

DESERTX



Index

4	DesertX Dream Wilder	32	ENGINE Born for off-roading
6	Designed to push you to the limit	38	ELECTRONICS Top-notch technology
9	DESIGN Post-heritage and digital	44	ACCESSORIES Configure your adventure
12	RR22 Livery	46	Accessories packages
18	21/18 capsule collection	50	Servicing and maintenance
23	CHASSIS Technology for the adventure of a lifetime	54	Technical data and equipment
28	ERGONOMICS The versatile sport-tool	60	Ducati Digital Experience
		62	BACKSTAGE Antoine's first time





Dream Wilder

Exploration. Enjoyment. Performance. And a keen desire to head out and set off towards the horizon. The identity of this bike leaves no room for doubt – a single glance will transport you into the world of the Dakar.

A bike that is perfectly at home off-road and that shifts the goalposts as to what you can do with a Ducati. Desert dunes, off-road tracks, dirt roads and mountain passes – with the new DesertX, your dreams know no limits.

Designed to push you to the limit

Equipped with 21" front 18" rear wheels, the new DesertX is designed to take on the most challenging off-road routes. The specific off-road development combined with the Ducati road-going expertise makes for a responsive, easy to handle bike that is at ease on any type of route and surface. Take your wildest dreams and make them come true. Bring your friends and prepare yourself and bring your friends to enjoy your dream journey. DesertX will bring you there.





DESIGN

Post-heritage and digital

The DesertX aesthetic is able to transmit a sense of Dakarian glory while also flaunting a modern look and feel. In the design of this adventure bike, the Centro Stile Ducati focused on two criteria - simplicity and robustness - for a minimalist aesthetic that communicates strength, while successfully combining form and function in the best possible way.

The full LED double DRL is integrated into the windscreen, with no other visible structure. Almost like a touch interface. Both post-heritage and digital at the same time. The robust design sees the calculated combining of curves, large and small, with lines that highlight the sports attitude of a bike that transmits the pleasure of adventure, right at the first glance.





RR22 Livery

The new RR22 livery is inspired by the one of the Audi RS Q e-tron that raced the Dakar 2022. Seen for the first time at the International Press Launch in Sardinia, on the DesertX ridden by Danilo Petrucci, the new livery will join the Matt Star White Silk version, completing the lineup.







Apparel

CAPSULE COLLECTION

21/18

The DesertX boasts such a strong identity that, for the first time, the Centro Stile Ducati has also developed a capsule collection that echoes its livery. Inspired by the iconic dakarian style, the collection is known as 21/18, in honour of the bike's wheel sizes.

The technical outfit includes jacket, pants and helmet and will be available as a limited edition. In addition there will be a range of lifestyle clothing specifically designed for this model that includes a sweatshirt, three t-shirts and a cap. Get ready for adventure with these exclusive DesertX garments.

Ducati Apparel Collection designed by **Drudi Performance**





CHASSIS

Technology for the adventure of a lifetime

DesertX is a versatile bike. Specifically developed for off-road, it is also safe and comfortable when touring, and equally at ease on everyday routes. The choices related to the chassis make for a bike that is easy to ride and that inspires trust and confidence on any type of road, even the most uneven.

21"/18" wheel combo

DesertX adopts the typical enduro set-up, with spoked wheels, 21" at the front and 18" at the rear. Ready and able to take on any kind of obstacle and asphalt.

Generous ground clearance of 250mm

An essential feature when off-roading, a ground clearance of 250 mm is particularly favourable during the most demanding off-road use.

**Wide range of tyres**

The Pirelli Scorpion Rally STR tubeless tyres offer the perfect balance between on road and off-road use. The different homologations obtained make for a wide range of alternative tyres.

Long-travel Kayaba suspension

The 46mm USD fork and the rear shock, both fully adjustable, are developed with Japanese brand Kayaba, an established name in the off-road world.

The best braking on any surface.

DesertX is equipped with Brembo brakes and Cornering ABS. The brake setting is made to offer the proper power when using on road, but also good modulation when off-roading and on challenging surfaces.

Front system

The front system involves Brembo M50 monobloc radial callipers with four 30 mm pistons, an axial master cylinder with adjustable levers, and a pair of 320 mm discs with aluminium flanges.

Rear system

At the rear, a Brembo two-piston floating calliper acts on a single 265 mm disc.



ERGONOMICS

The versatile sport-tool

A feeling of control and safety in all conditions. In the development of DesertX, Ducati test riders had a particular focus on the ergonomics.

The layout of seat, handlebar and footpegs is designed so that the rider can naturally move from a seated to a standing position. The shape of the tank, the seat and the other components ensures the best possible control of the bike. The seat height is 875mm and can be reduced with the low seat and lowered suspension kit, both available as accessories.

Rider and passenger comfort

The riding position is comfortable for both rider and passenger, thanks to the specific shape and padding of each of the two seats.

Load capacity and tyres

The load capacity is excellent, with almost 120 l of volume across the aluminium cases and top case. The tyres are tubeless and reliability and safety in case of puncture.



**Aerodynamics and heat management**

Heat management is made by well-calculated openings and flows of fresh air. Aerodynamic protection was developed with meticulous care in the definition of the shape and size of both the standard windshield and the accessory one.

Tank range

The range is adequate for long-distance trips thanks to a 21 liters fuel tank and the possibility to mount an auxiliary fuel tank, available as an accessory, adding an extra 8 liters of fuel.



ENGINE

Born for off-roading

DesertX is equipped with the latest evolution of the 937 cc Testastretta 11° desmo engine, the twin cylinder renowned for its solid performance, everyday usability and proven reliability



1.7 kg less

The new version of the Testastretta 11° introduces important updates with respect to the previous generation, which result in an overall weight saving of 1.7 kg.

Dedicated gear ratios

The work on the DesertX involved also the gearbox ratios, which were shortened in all the gears up to the fifth, particularly the first and the second gears to ensure a better off-road behaviour, while maintaining a long sixth gear for greater efficiency at high speeds.



ELECTRONICS

Top-notch technology

Electronics at the service of safety, versatility, and style. Like every Ducati, DesertX flaunts an advanced electronic equipment that ensures safety and performance in all conditions.

Rider aids suite

The electronic suite is enriched by a complete rider aids suite: Traction Control, Wheelie Control, Engine Brake Control, Cornering ABS, Quickshifter Up&Down and Cruise Control, for even more relaxing long-distance travels.

Light system

The light system is full LED. The headlight is composed by two bi-functional poly-ellipsoidal modules with Daytime Running Light and is designed to ensure great visibility, particularly important for a bike that can travel in all conditions, even with low visibility.





Riding Modes

The versatility of DesertX is also reflected in its 6 Riding Modes, 2 of which – the Enduro and the brand-new Rally – are specifically dedicated to the off-road riding experience. These are in addition to the Sport, Touring, Urban and Wet Riding Modes.

TFT & Connectivity

DesertX is equipped with a 5" high-resolution TFT colour display, vertically oriented and positioned to offer the best visibility even when riding while standing. The display is ready for the Ducati Multimedia System, available as an accessory, that allows to connect the smartphone via Bluetooth and to activate the Turn by Turn* navigation, that directly shows directions on the dashboard.

*The availability of services may vary depending on the country, smartphone model and operating system version.
The Ducati Multimedia System and Turn-by-Turn navigation are available as accessories.





1 Rear break



2 Passenger seat



3 Mono-shock absorber



4 Fork adjustments

ACCESSORIES

Configure the Ducati of your dreams.

This multi-faceted bike can be further customized thanks to a wide range of Ducati Performance accessories. Noteworthy are: the rally seat, which combines the rider and passenger saddles for a more effective off-road riding, and the 8-litre auxiliary fuel tank.

For touring purpose, the catalogue includes aluminium side panniers that, along with the top case, offer a total load capacity of almost 120 liters, auxiliary LED lights, a center stand and heated hand grips.

There is also a street legal exhaust and a racing one, both by Termignoni. The last one boosts up power and torque by 7% thanks to its dedicated mapping. All you have to do is choose the ideal DesertX for you and have fun configuring it to fit your riding style.

Configure

Choose the ideal DesertX for you and have fun configuring it to suit your riding style! Share your DesertX with friends and send it to your Ducati dealer who will contact you for an online consultation to discuss the current offers that best suit your needs.

Save your configuration to return to it at any time.

Calculate your payment

Ducati Financial Services offers favourable solutions for the financing of every model in the Ducati range. Personalise your financing and calculate the monthly instalments. You can then contact your dealer and discuss the best way to see your dream come true!



Go to configurator

For more information about the Ducati Performance range, tech specs and instructions, refer to a Ducati dealer or visit the Accessories section of [ducati.com](https://www.ducati.com)

Accessories packages

Rally



No place is too far or too difficult to reach with the new package of accessories, which includes an auxiliary tank for greater range and a rally seat for greater off-road riding comfort. The tank protection and protective headlight grille round out the package. The perfect equipment for limitless travel.

Auxiliary tank.
Adhesive tank protection.
Protective headlight grille.
Rally seat.

Sport



A set of accessories that emphasize the sport soul of this bike. Travelling becomes pure excitement with the homologated silencer, while the bike's unmistakable style is enhanced with the license plate holder and billet aluminium fuel cap, which give to DesertX an even bolder look. Quality, style, and design in one unique package

Billet aluminium fuel cap.
Number plate holder.
Silencer.

Off-road



No route will be off-limits. The engine guard plate, protective mesh for the water radiator, and steel tube engine guard better protect the bike's vital organs, the design of the accessories marrying perfectly with the bike's bold yet refined look, for travel beyond every horizon.

Engine guard plate.
Protective mesh for water radiator.
Steel tube engine guard.
Water pump protection.
Hand guards.

Urban



Ultimate riding pleasure and practicality during everyday rides and medium-range travel thanks to this accessory package that combines the spacious aluminium top case (with fixing plate) with the practical handlebar bag for personal items and the top case cushion for increased passenger comfort. Everyday comfort in perfect urban style, also ideal for a weekend away.

Aluminium top case.
Top case frame.
Cushion for aluminium top case.
Handlebar bag.

Touring



Long-range travel becomes a real pleasure, with a package of accessories that maximizes comfort and functionality, in all conditions. The spacious aluminium side panniers, the useful plug&play heated hand grips and the functional centre stand are what a rider needs to enjoy a travel with style and comfort.

Aluminium side cases.
Centre stand.
Heated hand grips.
Side case frames.

A bike that is ready for the most challenging off-road routes, in the desert for example, but that is also extremely intuitive and comfortable when travelling on the road.



[Go to configurator](#)

For more information about the Ducati Performance range, tech specs and instructions, refer to a Ducati dealer or visit the Accessories section of [ducati.com](https://www.ducati.com)

Servicing and maintenance

Safety as standard

The continuous work that Ducati carries out in terms of design, research and development has the specific aim of ensuring bikes are always cutting-edge and offer the ultimate level of active safety. A commitment that means defining increasingly advanced systems that heighten the level of rider control during the most delicate riding phases.

The Multistrada V4 can be fully customised in terms of its suspension, performance, comfort and safety and comes complete with the most advanced rider support systems, or rather Riding Modes, Power Mode, Cornering ABS, Ducati Traction Control, Ducati Wheelie Control, Ducati Cornering Light and Ducati Brake Light.

4 Ever Ducati

Ducati offers a 4-year warranty on all models of the Multistrada and DesertX family with the 4Ever Ducati warranty. Created to satisfy the desire to travel without restrictions and boundaries, Multistrada and DesertX are ready to expand your horizons of freedom. Increasingly strict and prolonged testing, improved production processes and advanced numerical simulations have enhanced the reliability of the Multistrada and desert family models to the highest level ever.

A guarantee that Ducati can offer you without borders, thanks to the solid growth of the global dealer network. A team constantly trained to treat your Ducati with the same care with which it is designed and assembled in Borgo Panigale.

To find out whether 4Ever Multistrada and 4Ever Ducati is available in your country and receive more details, visit your local Ducati dealer or visit ducati.com



4|Ever
Ducati
4 year warranty



Endless excitement

In designing each bike, Ducati always sets itself the goal of ensuring maximum reliability while reducing maintenance costs. A commitment that has seen it extend the main service interval to 30,000 km (18,000 miles), during which a valve clearance check and registration is carried out as required. Even the simplest operations, like the Oil Service, are now scheduled at 15,000 km (9,000 miles) or 24 months.

An interval that is unbeatable in the two-wheeled world and that only confirms the very high quality standards Ducati applies to its material selection and R&D processes. Ducati continuously invests in the technical training of its dealers. The specific knowledge of official Ducati Service network members means that all operations needed to keep every Ducati in perfect working order are meticulously carried out. Advanced equipment such as the Ducati Diagnosis System ensures every Ducati will always have the latest software updates so that the electronic systems continue to perform at the highest level.

Always by your side

One of Ducati's main goals is to offer every Ducatista the chance to enjoy unlimited and safe travel all over the world. To achieve this aim, Ducati offers a "fast delivery" original spares service, with delivery in 24/48 hours across 85% of the areas in which it operates. With a distribution network that covers more than 92 countries, thanks to 790 official Dealers and Service Points*, choosing a Ducati means you can travel worry free and in total freedom, wherever the road may take you, and count on support from our extensive Dealer network that ensures Ducati quality and professionalism is always close at hand.

790 Authorised dealers and service points

92 World countries

*Information updated as of February 2022



*Equal to 18,000 miles.



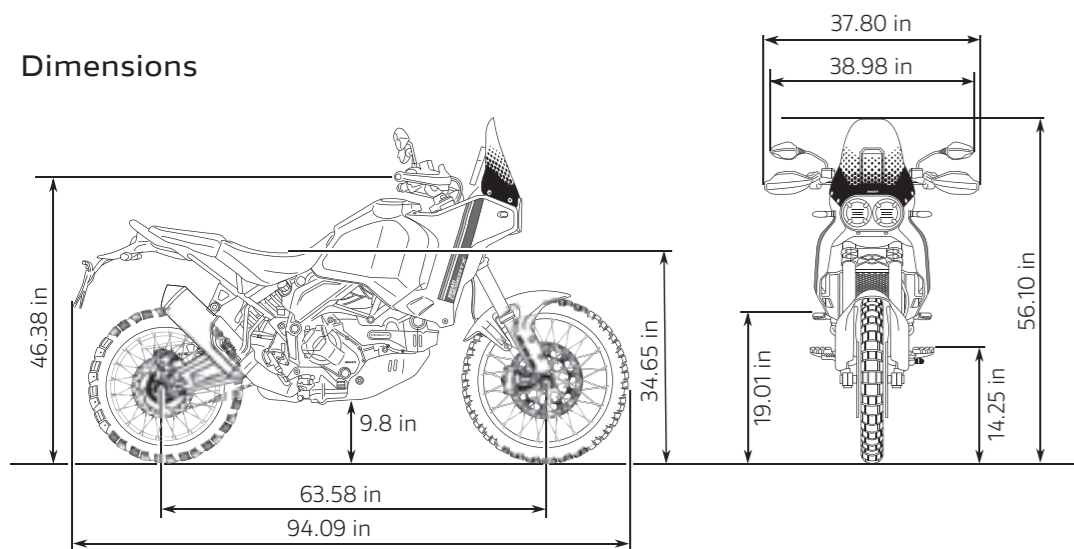
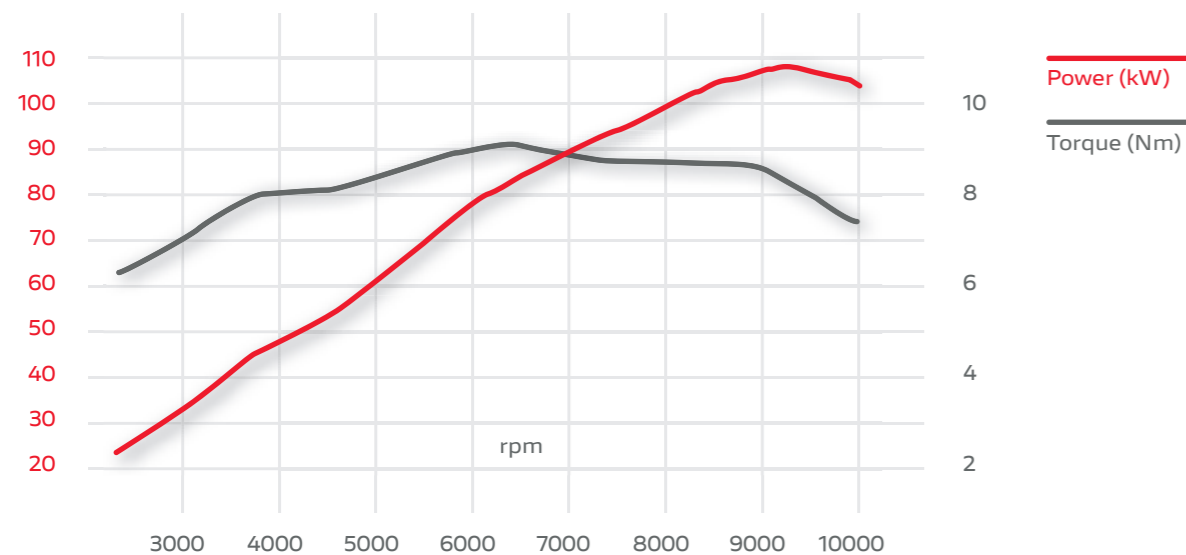

Technical data and equipment

DESERTX**Dimensions****Power and torque**

Engine	
Engine	Ducati Testastretta 11°, L-Twin cylinders, Desmodromic valvetrain, 4 valves per cylinder, liquid cooled
Displacement	937 cc
Bore X Stroke	94 x 67.5 mm
Compression ratio	13.3:1
Power	110 hp (81 kW) @ 9,250 rpm
Torque	92 Nm (68 lb-ft, 9.4 kgm) @ 6,500 rpm
Fuel injection	Bosch electronic fuel injection system, Ø53 mm throttle bodies with ride-by-wire system
Exhaust	Stainless steel single muffler, catalytic converter and 2 lambda probes
Transmission	
Gearbox	6 speed
Primary drive	Straight cut gears, ratio 1.85 : 1
Ratio	1=38/14, 2=31/17, 28=28/20, 4=26/22, 5=24/23, 6=23/25
Final drive	Chain, front sprocket Z15, rear sprocket Z49
Clutch	Slipper and self-servo wet multiplate clutch with hydraulic control

Chassis	
Frame	Tubular steel trellis frame
Front suspension	KYB Ø 46 mm upside-down fork, fully adjustable
Front wheel	Cross-spoked, tubeless, 2.15"x21"
Front tyre	Pirelli Scorpion Rally STR 90/90 - 21 M/C 54V M+S TL (A)
Rear Suspension	KYB monoshock, fully adjustable, remote preload adjustment, aluminium double-sided swingarm
Rear wheel	Cross-spoked, tubeless, 4.5"x18"
Rear tyre	Pirelli Scorpion Rally STR 150/70 R18 M/C 70V M+S TL
Wheel travel (front/rear)	230 mm (9.06 in) - 220 mm (8.66 in)
Front brake	2 x Ø 320 mm aluminum flange semi-floating discs, Radial mount Brembo monobloc 4-pistons calipers, Bosch Cornering ABS
Rear brake	Ø 265 mm disc, Brembo floating 2 pistons caliper, Bosch Cornering ABS
Instrumentation	5" TFT colour display

Dimensions and Weights	
Dry weight	202 kg (445 lb)
Kerb weight	223 kg (492 lb)
Seat height	875 mm (34.4 in)
Wheelbase	1608 mm
Rake	27,6°
Trail	122 mm
Fuel tank capacity	21 l (5.54 US gal)
Number of seats	Dual seat
Safety equipment	
Cornering ABS, Ducati Traction Control	
Standard equipment	
Riding Modes, Power Modes, Ducati Wheelie Control (DWC), Engine Brake Control (EBC), Ducati Quick Shift up/down (DQS), Cruise control, full LED lighting system, DRL, Ducati brake light (DBL), USB power socket, 12V socket, self canceling turn indicators, Steering damper	
Ready for	
Ducati Multimedia System (DMS), Antitheft system, Turn by turn navigation via app*, fog lights, heated grips, auxiliary fuel tank	

Warranty and Maintenance**	
Warranty	48 months, unlimited mileage
Maintenance	15,000 km (9,000 miles) / 24 months
Valve clearance check	30,000 km (18,000 miles)
Emissions and Consumption***	
Standard	Euro 5
CO₂ emissions	133 g/km
Consumption	5.6 l/100 km



Indication of mileage at the first Desmo Service, or rather the first service during which valve clearance is checked and adjusted if necessary.

Equal to 18,000 miles.



The DesertX is also available for holders of limited driving license in a version with reduced power to 35 kW. Contact your dealer to check availability.

*These systems are accessories. The availability of the services may vary depending on the country, smartphone model and operating system version.

** Only for countries where 4Ever Ducati warranty applies

*** Only for countries where Euro 5 standard applies.





Matt Star White Silk





Ducati Digital Experience

A mission for every channel. Continuous updating on the innovation and passion for which our work stands out. We transform emotions into exclusive content. Just a click away.

Follow us on:

-  www.ducati.com
-  [@ducati](#)
-  [@DucatiMotor](#)
-  [Ducati Motor Holding](#)

-  [@ducati](#)
-  [Ducati Motor Holding](#)
-  [@ducati_official](#)

MyDucati App

MyDucati is the personal area for every Ducatista, offering a wide range of services accessible with a single login from both the web and the app. Explore all the features of the MyDucati world and enjoy a multi-channel, customised experience wherever you are.

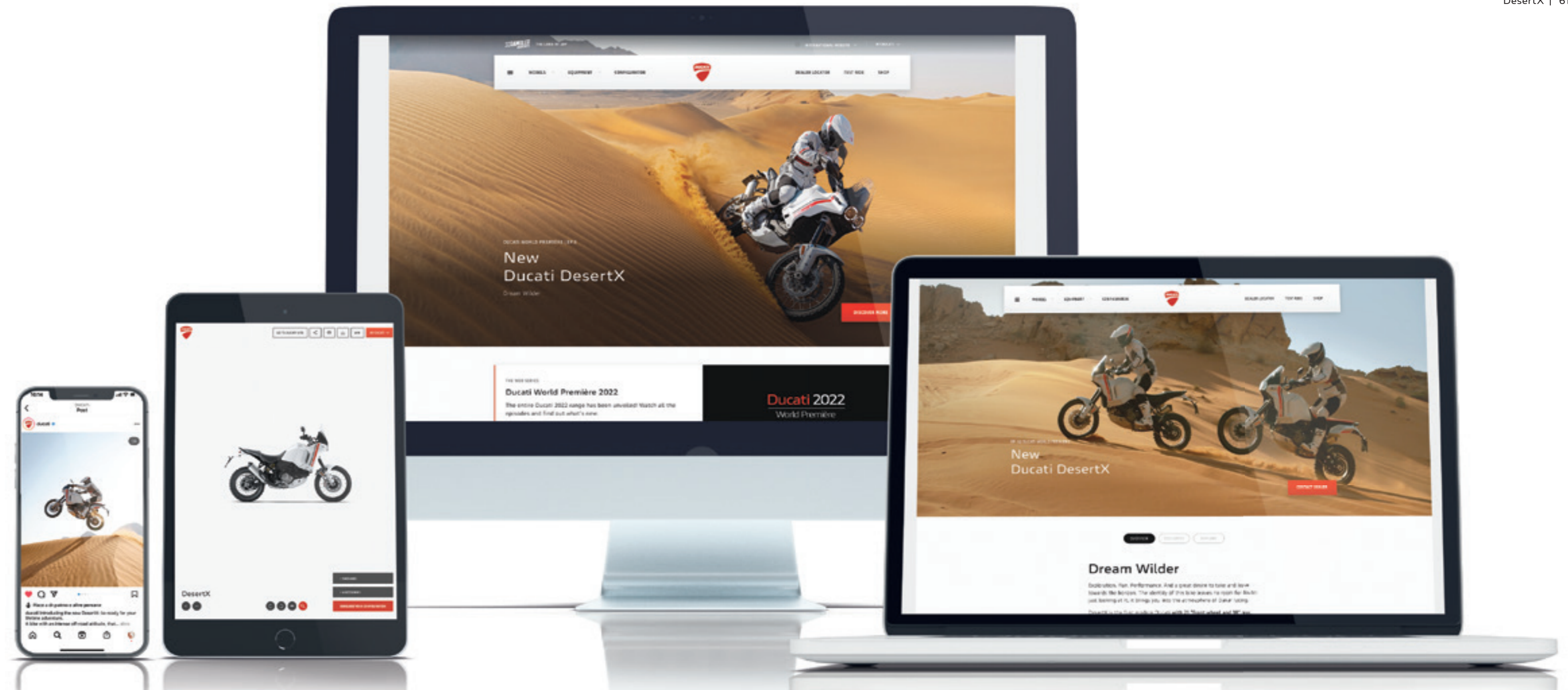



BACKSTAGE

Antoine's first time

DesertX is born to create adventure.

Antoine Méo, five-time world enduro champion, and Pierluigi Zampieri, Ducati Vehicle R&D Director. The rider and the engineer. Friends and world enduro champions.

Antoine Méo tells us just how exciting the DesertX is to ride, as he tests it for the first time in the desert.



Riding a motorcycle is the most exciting way to enjoy the road, and offering the utmost safety to the motorcyclist is Ducati's commitment. Ducati bikes are increasingly easy to handle, reliable and better equipped to guarantee maximum safety and enhance riding pleasure. Technical clothing is made with more and more advanced materials for adequate protection and increased visibility. The safety of motorcyclists is Ducati's commitment. For more information visit the safety section of the Ducati site (www.ducati.com).

Warning: The photos and technical information in this catalogue may refer to prototypes subject to modifications during production and are purely for illustration and reference purposes, and are therefore not binding on Ducati Motor Holding S.p.A. Sole Shareholder Company - Company subject to the direction and coordination of AUDI AG ("Ducati"). Ducati cannot be held responsible for any print and/or translation errors. This catalogue is transnational and therefore some products may not be available and/or their features may vary in accordance with local laws. Not all colours and versions are available in each country. Ducati reserves the right to make changes and improvements to any product without obligation of prior notice or to make such changes to products already sold. Further characteristics of the products are contained in the pertinent owner's manuals.



ducati.com



The products represented are not definitive versions and are therefore subject to significant changes at Ducati's discretion without prior notice. The photographs published in this catalogue show only professional riders under controlled street conditions. Do not attempt to imitate such riding behaviour as it could be dangerous for you or other people on the road. This catalogue, including but not limited to the trademarks, logos, texts, images, graphics and table of contents herein, constitute Ducati intellectual property, or in any event Ducati has the right to reproduce it; any reproduction, modification or other whole or partial use of the catalogue or its contents, including publication on the Internet without the prior written consent of Ducati, is prohibited.

Actual fuel consumption may vary based on many factors, including but not limited to riding style, maintenance performed, weather conditions, surface characteristics, tyre pressure, load, weight of the rider and the passenger, accessories.

Ducati indicates the dry weight of the motorcycle excluding battery, lubricants and coolants for liquid-cooled models. The weights in running order are considered with all operating fluids, standard equipment and the fuel tank filled to 90% of its useful capacity (UE regulation no. 168/2013). For more information visit www.ducati.com.

December 2022

